



Plate for downlight 4"

Product Dimensions

 
SCALE : 1:1
Measure Tolerance is: ±0.15 mm, ±0.01in
Material: Aluminium

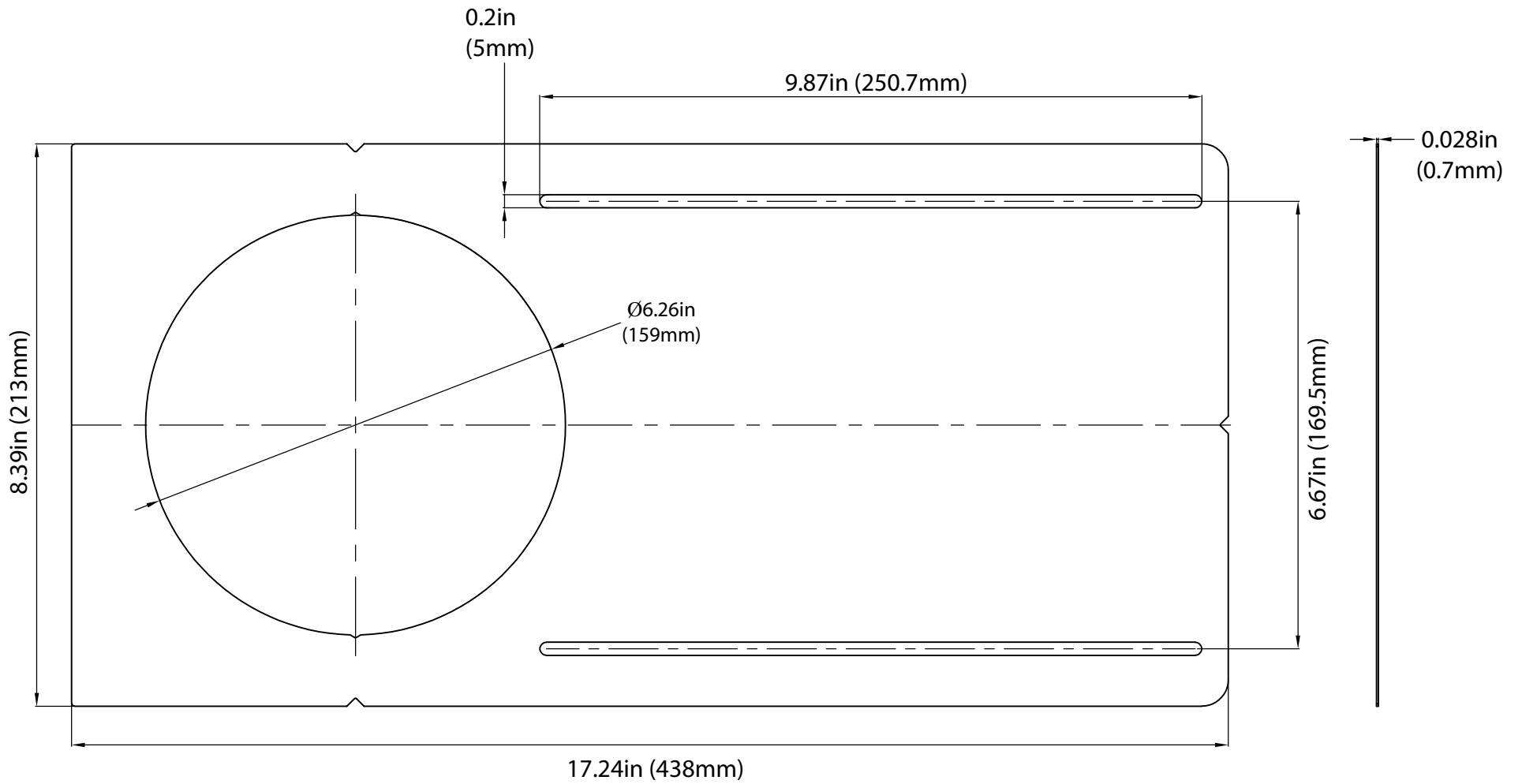

Plate for downlight 6"

Product Dimensions

SCALE : 1:1
Measure Tolerance is: $\pm 0.15\text{ mm}$, $\pm 0.01\text{ in}$
Material: Aluminium

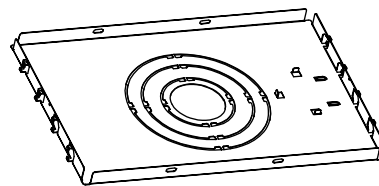
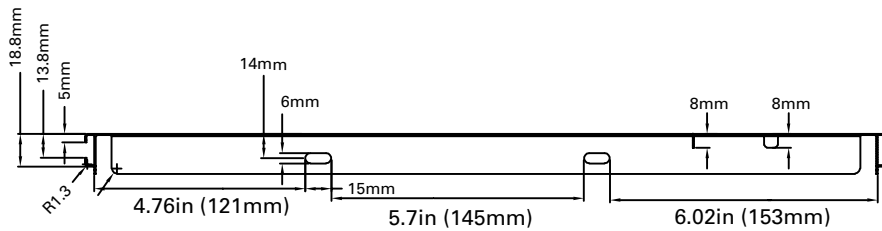
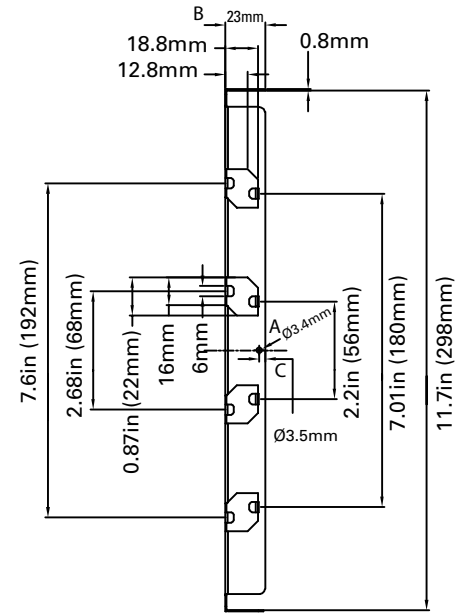
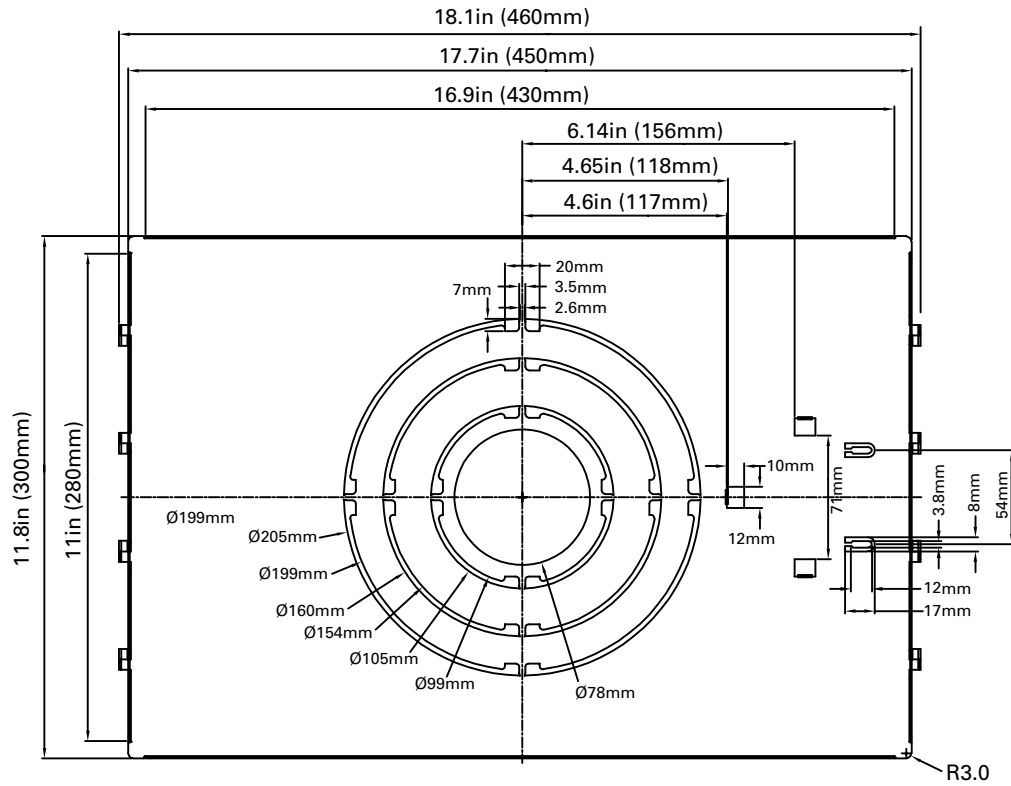
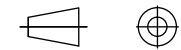

Plate for Downlight

P10375 PLT-NC/DL/3-4-6-8



SCALE : 1:1

Measure Tolerance is:
±0.15 mm, ±0.01 in

Material: Aluminium